

# Installation Manual

AUDI A3 5DR  
AU-A3-5-B



## COMPONENTS INCLUDED

## SHADES

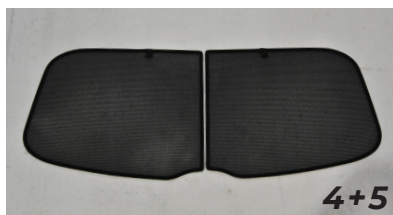
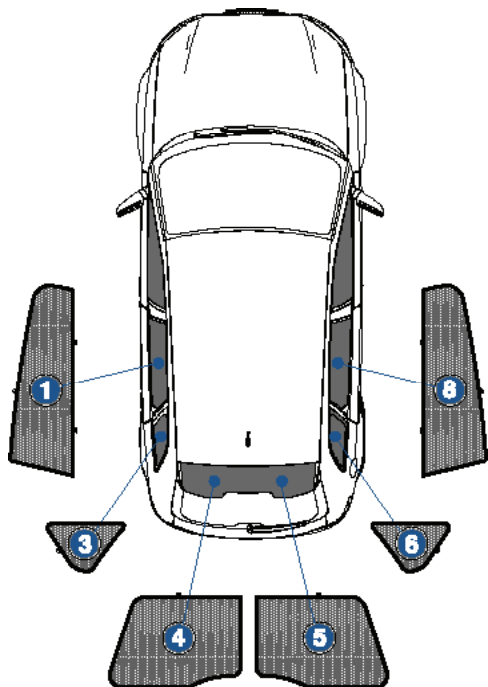

## FIXING CLIPS



CL-M01 x 2



CL-M04 x 2



CL-M13 x 6



CL-M14 x 1

# Side Shade Installation

AUDI A3 5DR  
AU-A3-5-B

## COMPONENTS NEEDED:



### STEP #1

ATTACH CLIPS ON SHADE EDGES



### STEP #2

POSITION THE SIDE SHADE

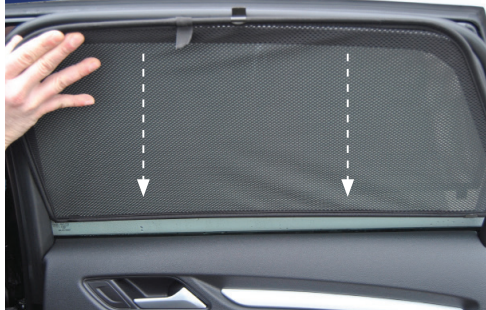

### STEP #3

INSERT CLIPS INSIDE WEATHERSTRIP

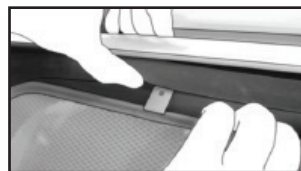

### STEP #4

ENSURE SECURELY FITTED IN PLACE

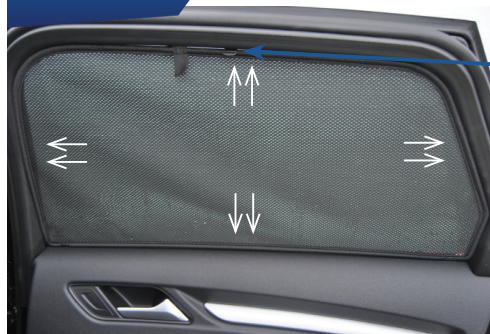

**CAR**  
SHADES

# Quarter Light Shade Installation

AUDI A3 5DR  
AU-A3-5-B

COMPONENTS NEEDED:



## STEP #1

ATTACH CLIPS ON SHADE EDGES



## STEP #2

INSERT CLIPS BEHIND INTERIOR TRIM



## STEP #3

ENSURE SECURELY FITTED IN PLACE

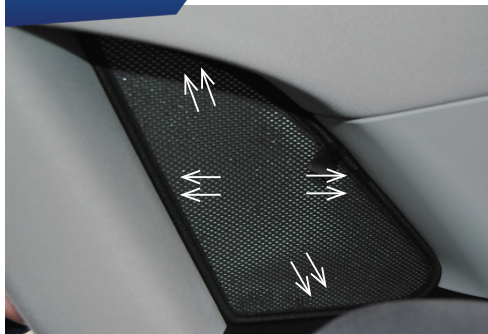

**CAR**  
SHADES

# Rear Shade Installation

AUDI A3 5DR  
AU-A3-5-B

## COMPONENTS NEEDED:



CL-M01 x 2



CL-M14 x 1

### STEP #1

ATTACH CLIPS ON SHADE EDGES



### STEP #2

POSITION THE REAR SHADE

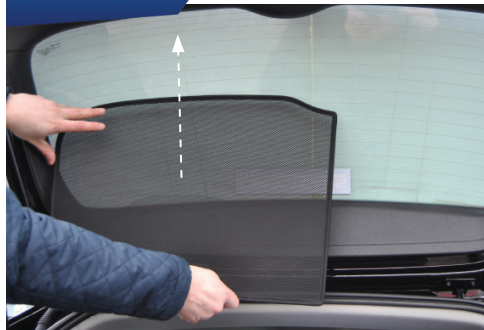

### STEP #3

INSERT CLIPS BEHIND INTERIOR TRIM



### STEP #4

REPEAT THE PROCESS ON OTHER SHADE



### STEP #5

ENSURE SECURELY FITTED IN PLACE



**CAR**  
SHADES